

M54532P/FP

4-UNIT 1.5A DARLINGTON TRANSISTOR ARRAY WITH CLAMP DIODE

DESCRIPTION

M54532P and M54532FP are four-circuit Darlington transistor arrays with clamping diodes. The circuits are made of NPN transistors. Both the semiconductor integrated circuits perform high-current driving with extremely low input-current supply.

FEATURES

- High breakdown voltage ($BV_{CEO} \geq 50V$)
- High-current driving ($I_{c(max)} = 1.5A$)
- With clamping diodes
- Wide operating temperature range ($T_a = -20$ to $+75^\circ C$)

APPLICATION

Drives of relays and printers, digit drives of indication elements (LEDs and lamps), and power amplification

FUNCTION

The M54532P and M54532FP each have four circuits consisting of NPN Darlington transistors. They have resistance of 340Ω between input transistor bases and input pins. A clamping diode is provided between each output pin (collector) and COM pin. The output transistor emitters are all connected to the GND pin.

The collector current is 1.5A maximum. Collector-emitter supply voltage is 50V maximum.

The M54532FP is enclosed in a molded small flat package, enabling space-saving design.

PIN CONFIGURATION

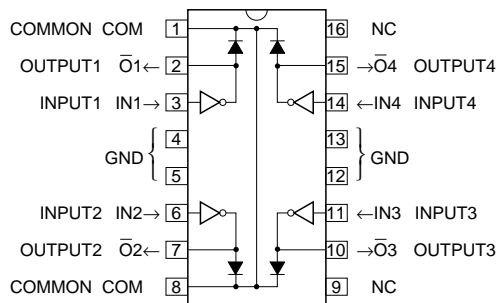

16P4(P)
Package type 16P2N-A(FP) NC : No connection

CIRCUIT DIAGRAM

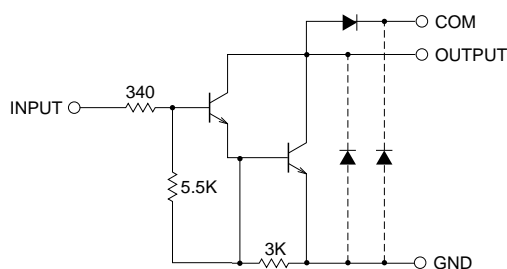

The four circuits share the COM and GND.
The diode, indicated with the dotted line, is parasitic, and cannot be used.

Unit : Ω

ABSOLUTE MAXIMUM RATINGS (Unless otherwise noted, $T_a = -20 \sim +75^\circ C$)

Symbol	Parameter	Conditions	Ratings	Unit
V_{CEO}	Collector-emitter voltage	Output, H	$-0.5 \sim +50$	V
I_C	Collector current	Current per circuit output, L	1.5	A
V_I	Input voltage		$-0.5 \sim +10$	V
V_R	Clamping diode reverse voltage		50	V
I_F	Clamping diode forward current	Pulse Width $\leq 10ms$, Duty Cycle $\leq 5\%$	1.5	A
		Pulse Width $\leq 100ms$, Duty Cycle $\geq 5\%$	1.25	
P_d	Power dissipation	$T_a = 25^\circ C$, when mounted on board	1.92(P)/1.00(FP)	W
T_{opr}	Operating temperature		$-20 \sim +75$	$^\circ C$
T_{stg}	Storage temperature		$-55 \sim +125$	$^\circ C$

M54532P/FP

4-UNIT 1.5A DARLINGTON TRANSISTOR ARRAY WITH CLAMP DIODE

RECOMMENDED OPERATING CONDITIONS (Unless otherwise noted, Ta = -20 ~ +75°C)

Symbol	Parameter	Limits			Unit	
		min	typ	max		
Vo	Output voltage	0	—	50	V	
Ic	Collector current (Current per 1 circuit when 4 circuits are coming on simultaneously)	Duty Cycle P : no more than 4% FP : no more than 2%	0	—	1.25	A
		Duty Cycle P : no more than 18% FP : no more than 9%	0	—	0.7	
VIH	"H" input voltage	3	—	6	V	
VIL	"L" input voltage	0	—	0.4	V	

ELECTRICAL CHARACTERISTICS (Unless otherwise noted, Ta = -20 ~ +75°C)

Symbol	Parameter	Test conditions	Limits			Unit
			min	typ*	max	
V (BR) CEO	Collector-emitter breakdown voltage	ICEO = 100μA	50	—	—	V
VCE (sat)	Collector-emitter saturation voltage	II = 2mA, IC = 1.25A	—	1.3	2.2	V
		II = 2mA, IC = 0.7A	—	1.1	1.7	
II	Input current	VI = 3V	—	5	8.5	mA
IR	Clamping diode reverse current	VR = 50V	—	—	100	μA
VF	Clamping diode forward voltage	IF = 1.25A	—	1.6	2.3	V
hFE	DC amplification factor	VCE = 4V, IC = 1A, Ta = 25°C	800	7000	—	—

* : The typical values are those measured under ambient temperature (Ta) of 25°C. There is no guarantee that these values are obtained under any conditions.

SWITCHING CHARACTERISTICS (Unless otherwise noted, Ta = 25°C)

Symbol	Parameter	Test conditions	Limits			Unit
			min	typ	max	
ton	Turn-on time	CL = 15pF (note 1)	—	10	—	ns
toff	Turn-off time		—	500	—	ns

NOTE 1 TEST CIRCUIT

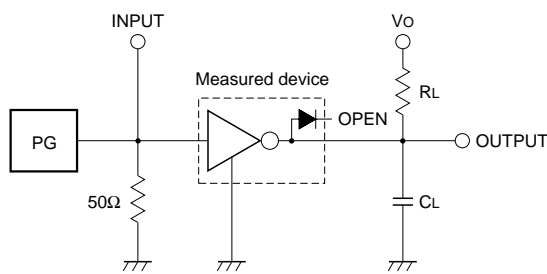

- (1) Pulse generator (PG) characteristics : PRR = 1kHz, tw = 10μs, tr = 6ns, tf = 6ns, Zo = 50Ω, VP = 3VP-P
- (2) Input-output conditions : RL = 8.3Ω, Vo = 10V
- (3) Electrostatic capacity CL includes floating capacitance at connections and input capacitance at probes

TIMING DIAGRAM

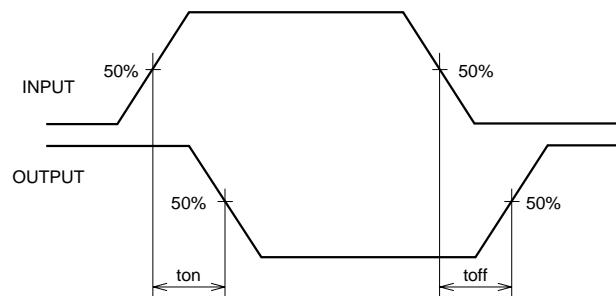

4-UNIT 1.5A DARLINGTON TRANSISTOR ARRAY WITH CLAMP DIODE

TYPICAL CHARACTERISTICS

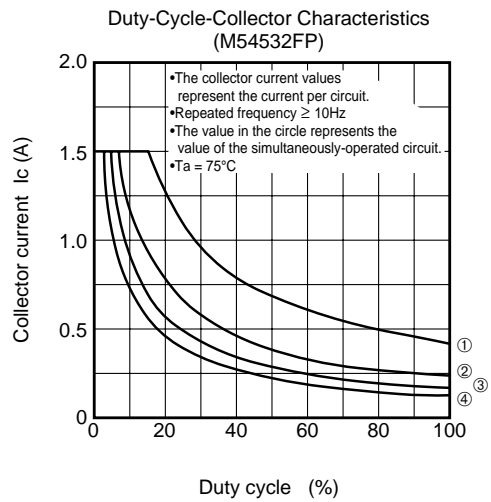
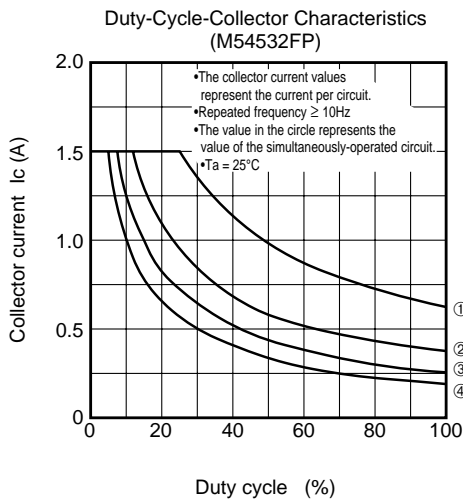
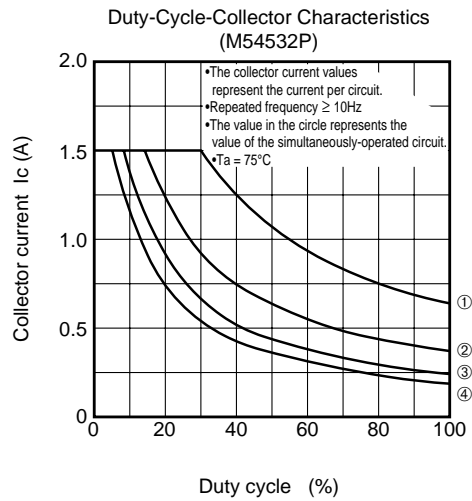
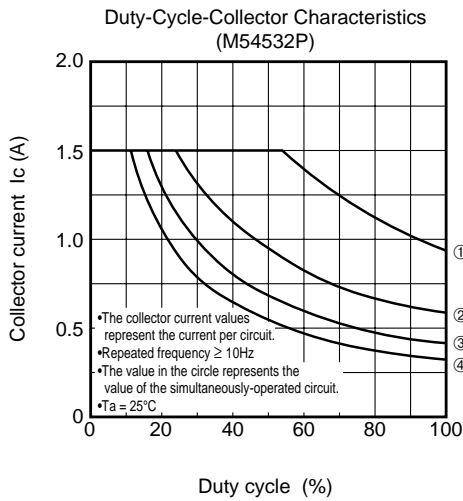
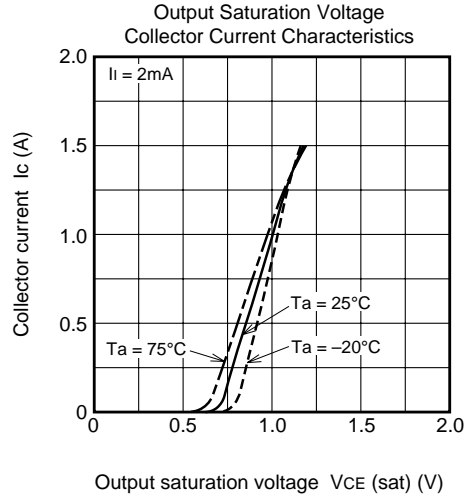
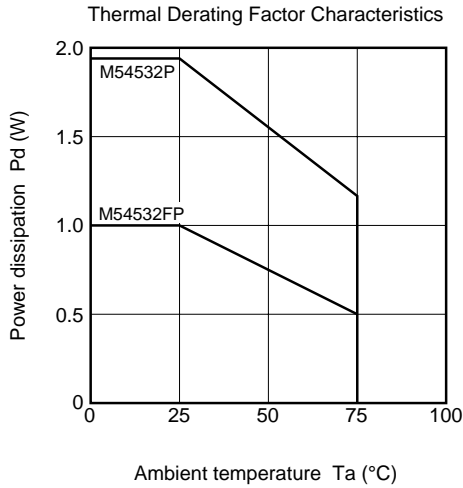

4-UNIT 1.5A DARLINGTON TRANSISTOR ARRAY WITH CLAMP DIODE

