

PRELIMINARY
 Notice: This is not a final specification.
 Some parametric limits are subject to change.

MITSUBISHI SEMICONDUCTOR <TRANSISTOR ARRAY>

M63806P/FP/KP

8-UNIT 300mA TRANSISTOR ARRAY

DESCRIPTION

M63806P/FP/KP are eight-circuit Single transistor arrays. The circuits are made of NPN transistors. Both the semiconductor integrated circuits perform high-current driving with extremely low input-current supply.

FEATURES

- Three package configurations (P, FP, and KP)
- Medium breakdown voltage ($BV_{CEO} \geq 35V$)
- Synchronizing current ($I_{C(max)} = 300mA$)
- Low output saturation voltage
- Wide operating temperature range ($T_a = -40$ to $+85^\circ C$)

APPLICATION

Driving of digit drives of indication elements (LEDs and lamps) with small signals

FUNCTION

The M63806P/FP/KP each have eight circuits consisting of NPN transistor. The transistor emitters are all connected to the GND pin. The transistors allow synchronous flow of 300mA collector current. A maximum of 35V voltage can be applied between the collector and emitter.

PIN CONFIGURATION

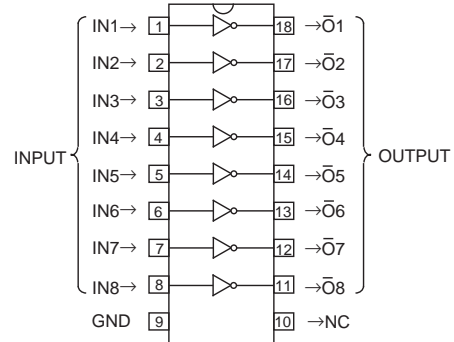

Package type 18P4G(P)

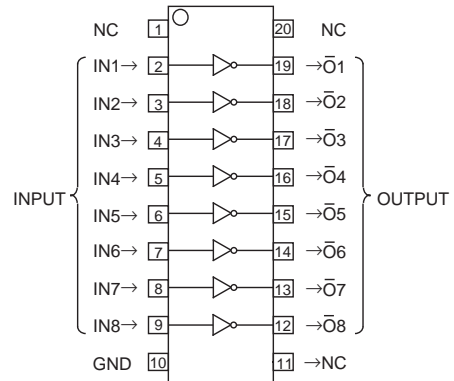

NC : No connection

20P2N-A(FP)

Package type 20P2E-A(KP)

CIRCUIT DIAGRAM

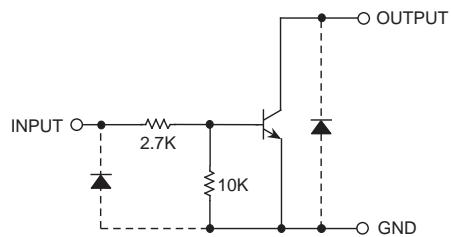

The eight circuits share the GND.

The diode, indicated with the dotted line, is parasitic, and cannot be used.

Unit: Ω

PRELIMINARY
 Notice: This is not a final specification.
 Some parametric limits are subject to change.

M63806P/FP/KP

8-UNIT 300mA TRANSISTOR ARRAY

ABSOLUTE MAXIMUM RATINGS (Unless otherwise noted, Ta = -40 ~ +85°C)

Symbol	Parameter	Conditions	Ratings	Unit	
V _{CEO}	Collector-emitter voltage	Output, H	-0.5 ~ +35	V	
I _C	Collector current	Current per circuit output, L	300	mA	
V _I	Input voltage		-0.5 ~ +35	V	
P _d	Power dissipation	Ta = 25°C, when mounted on board	M63806P	1.79	W
			M63806FP	1.10	
			M63806KP	0.68	
T _{opr}	Operating temperature		-40 ~ +85	°C	
T _{stg}	Storage temperature		-55 ~ +125	°C	

RECOMMENDED OPERATING CONDITIONS (Unless otherwise noted, Ta = -40 ~ +85°C)

Symbol	Parameter	Test conditions	Limits			Unit	
			min	typ	max		
V _O	Output voltage		0	—	35	V	
I _C	Collector current (Current per 1 circuit when 8 circuits are coming on simultaneously)	M63806P	Duty Cycle no more than 50%	0	—	250	mA
			Duty Cycle no more than 100%	0	—	170	
		M63806FP	Duty Cycle no more than 30%	0	—	250	
			Duty Cycle no more than 100%	0	—	130	
		M63806KP	Duty Cycle no more than 12%	0	—	250	
			Duty Cycle no more than 100%	0	—	100	
V _{IN}	Input voltage		0	—	20	V	

ELECTRICAL CHARACTERISTICS (Unless otherwise noted, Ta = 25°C)

Symbol	Parameter	Test conditions	Limits			Unit
			min	typ	max	
V (BR) CEO	Collector-emitter breakdown voltage	I _{CEO} = 10μA	35	—	—	V
V _{CE(sat)}	Collector-emitter saturation voltage	I _{IN} = 1mA, I _C = 10mA	—	—	0.2	V
		I _{IN} = 2mA, I _C = 150mA	—	—	0.8	
V _{IN(on)}	"On" input voltage	I _{IN} = 1mA, I _C = 10mA	2.4	3.5	4.2	V
h _{FE}	DC amplification factor	V _{CE} = 10V, I _C = 10mA	50	—	—	—

SWITCHING CHARACTERISTICS (Unless otherwise noted, Ta = 25°C)

Symbol	Parameter	Test conditions	Limits			Unit
			min	typ	max	
t _{on}	Turn-on time	C _L = 15pF (note 1)	—	125	—	ns
t _{off}	Turn-off time		—	250	—	ns

PRELIMINARY
 Notice: This is not a final specification.
 Some parametric limits are subject to change.

M63806P/FP/KP

8-UNIT 300mA TRANSISTOR ARRAY

NOTE 1 TEST CIRCUIT

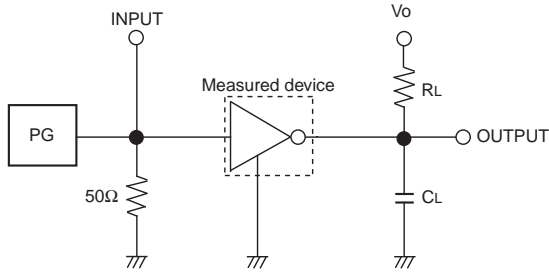

- (1) Pulse generator (PG) characteristics : PRR = 1kHz, $t_w = 10\mu s$, $t_r = 6ns$, $t_f = 6ns$, $Z_o = 50\Omega$, $V_{IH} = 3V$
- (2) Input-output conditions : $R_L = 220\Omega$, $V_o = 35V$
- (3) Electrostatic capacity C_L includes floating capacitance at connections and input capacitance at probes

TIMING DIAGRAM

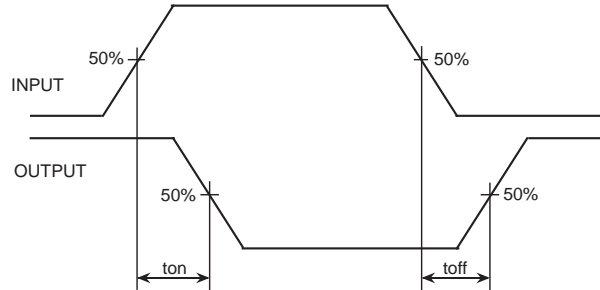

TYPICAL CHARACTERISTICS

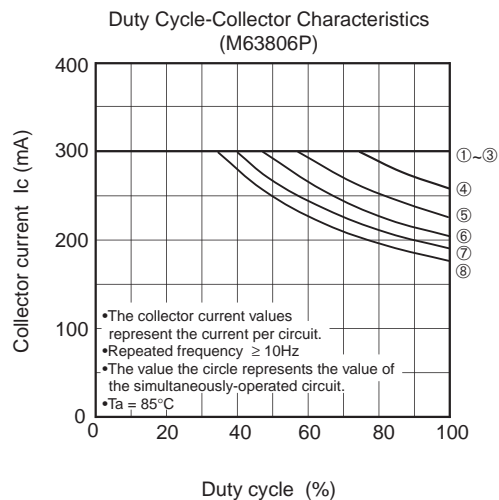
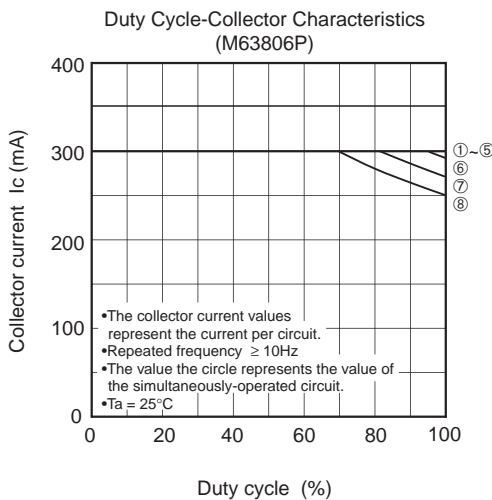
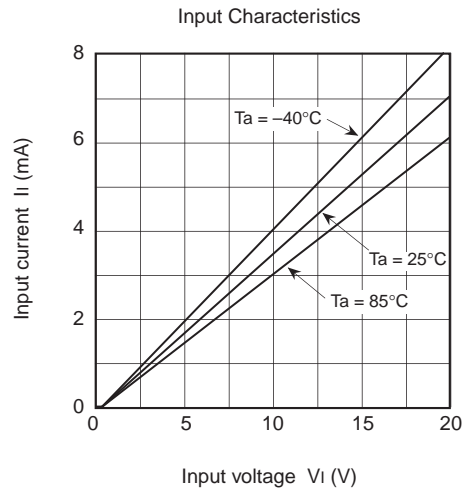
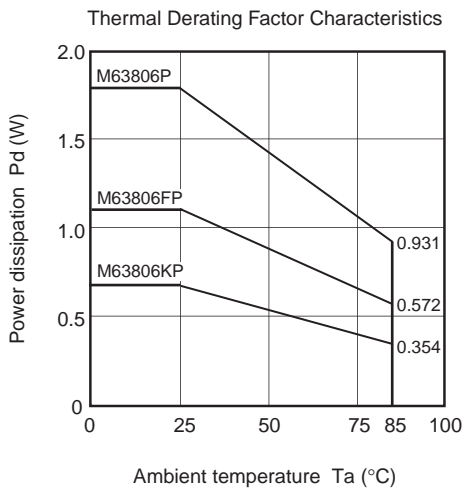

PRELIMINARY
 Notice: This is not a final specification.
 Some parametric limits are subject to change.

M63806P/FP/KP

8-UNIT 300mA TRANSISTOR ARRAY

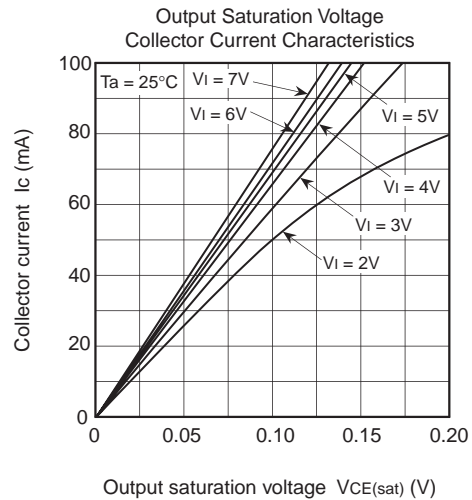
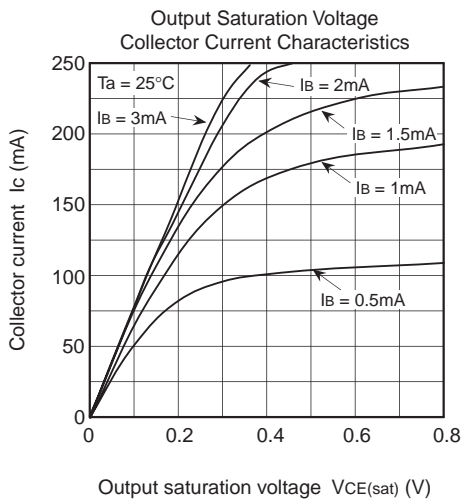
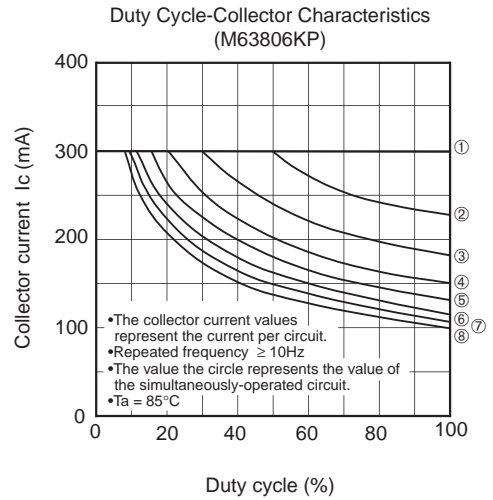
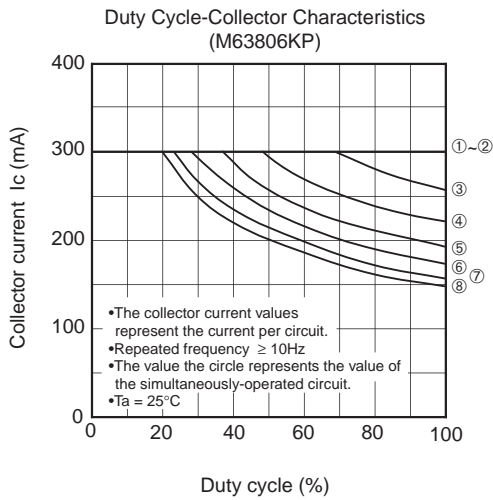
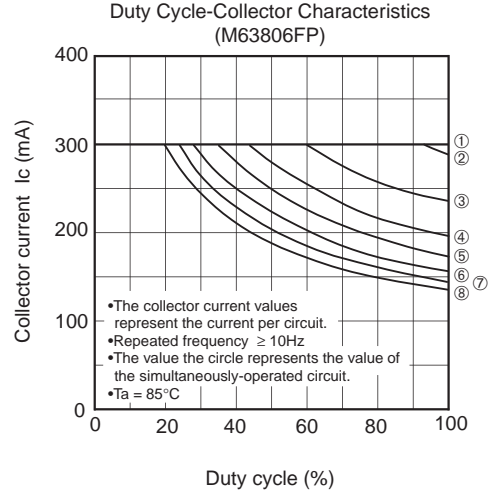
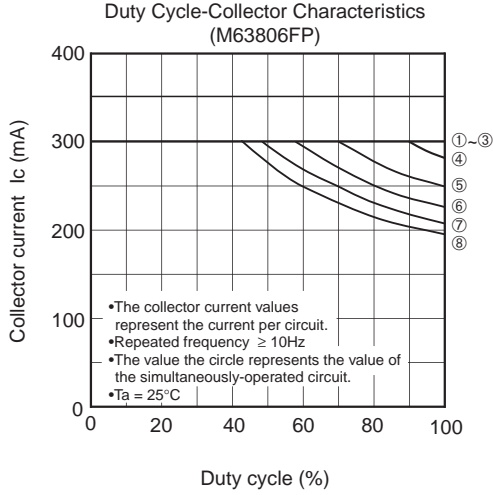

PRELIMINARY
 Notice: This is not a final specification.
 Some parametric limits are subject to change.

M63806P/FP/KP

8-UNIT 300mA TRANSISTOR ARRAY

