

# M63828WP/DP

Taiwan A'ssy product 7-UNIT 500mA DARLINGTON TRANSISTOR ARRAY WITH CLAMP DIODE

## DESCRIPTION

M63828WP and M63828DP are seven-circuit Darlington transistor arrays with clamping diodes. The circuits are made of NPN transistors. Both the semiconductor integrated circuits perform high-current driving with extremely low input-current supply.

## FEATURES

- Two package configurations (WP/DP)
- High breakdown voltage ( $BV_{CEO} \geq 50V$ )
- High-current driving ( $I_{c(max)} = 500mA$ )
- With clamping diodes
- Driving available with TTL, PMOS IC output
- Wide operating temperature range ( $T_a = -40$  to  $+85^\circ C$ )

## APPLICATION

Drives of relays and printers, digit drives of indication elements (LEDs and lamps), and MOS-bipolar logic IC interfaces

## FUNCTION

The M63828WP and M63828DP each have seven circuits consisting of NPN Darlington transistors. These ICs have resistance of  $10.5k\Omega$  between input transistor bases and input pins. A spike-killer clamping diode is provided between each output pin (collector) and COM pin (pin 9). The output transistor emitters are all connected to the GND pin (pin 8). The collector current is 500mA maximum. Collector-emitter supply voltage is 50V maximum.

## PIN CONFIGURATION

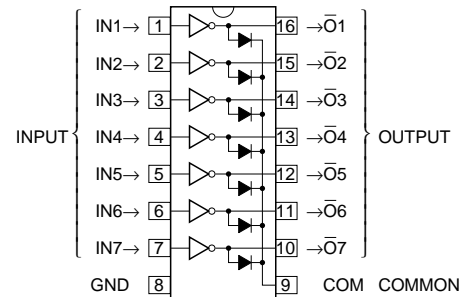

16P4X-A(WP)  
Package type 16P2X-B(DP)

## CIRCUIT DIAGRAM

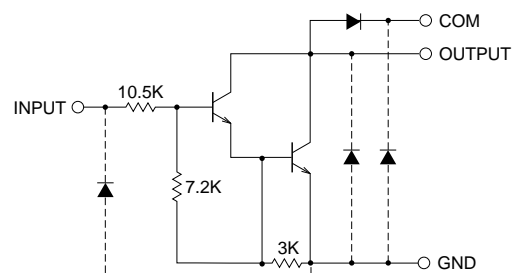

The seven circuits share the COM and GND.

The diode, indicated with the dotted line, is parasitic, and cannot be used.

Unit :  $\Omega$

## ABSOLUTE MAXIMUM RATINGS (Unless otherwise noted, $T_a = -40 \sim +85^\circ C$ )

Symbol	Parameter	Conditions	Ratings	Unit
$V_{CEO}$	Collector-emitter voltage	Output, H	$-0.5 \sim +50$	V
$I_C$	Collector current	Current per circuit output, L	500	mA
$V_I$	Input voltage		$-0.5 \sim +30$	V
$I_F$	Clamping diode forward current		500	mA
$V_R$	Clamping diode reverse voltage		50	V
$P_d$	Power dissipation	$T_a = 25^\circ C$ , when mounted on board	1.47(WP)/1.00(DP)	W
$T_{opr}$	Operating temperature		$-40 \sim +85$	$^\circ C$
$T_{stg}$	Storage temperature		$-55 \sim +125$	$^\circ C$

Taiwan A'ssy product

7-UNIT 500mA DARLINGTON TRANSISTOR ARRAY WITH CLAMP DIODE

**RECOMMENDED OPERATING CONDITIONS** (Unless otherwise noted, Ta = -40 ~ +85°C)

Symbol	Parameter	Limits			Unit	
		min	typ	max		
Vo	Output voltage	0	—	50	V	
Ic	Collector current (Current per 1 circuit when 7 circuits are coming on simultaneously)	Duty Cycle WP : no more than 8% DP : no more than 5%	0	—	400	mA
		Duty Cycle WP : no more than 30% DP : no more than 20%	0	—	200	
VIH	"H" input voltage	Ic ≤ 400mA	5	—	25	V
VIL	"L" input voltage		0	—	0.8	V

**ELECTRICAL CHARACTERISTICS** (Unless otherwise noted, Ta = 25°C)

Symbol	Parameter	Test conditions	Limits			Unit
			min	typ	max	
V (BR) CEO	Collector-emitter breakdown voltage	ICEO = 100μA	50	—	—	V
VCE (sat)	Collector-emitter saturation voltage	II = 500μA, IC = 350mA	—	1.2	1.6	V
		II = 350μA, IC = 200mA	—	1.0	1.3	
		II = 250μA, IC = 100mA	—	0.9	1.1	
II	Input current	VI = 10V	—	0.9	1.5	mA
VF	Clamping diode forward voltage	IF = 350mA	—	1.4	2.0	V
IR	Clamping diode reverse current	VR = 50V	—	—	100	μA
hFE	DC amplification factor	VCE = 2V, IC = 350mA	1000	3000	—	—

**SWITCHING CHARACTERISTICS** (Unless otherwise noted, Ta = 25°C)

Symbol	Parameter	Test conditions	Limits			Unit
			min	typ	max	
ton	Turn-on time	CL = 15pF (note 1)	—	30	—	ns
toff	Turn-off time		—	450	—	ns

**NOTE 1 TEST CIRCUIT**

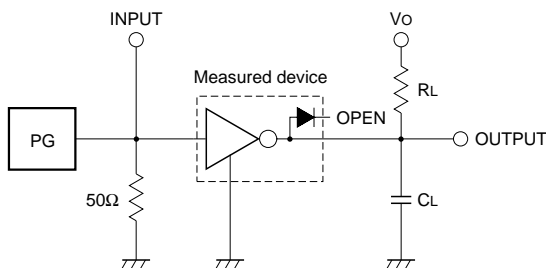

- (1) Pulse generator (PG) characteristics : PRR = 1kHz,  
tw = 10μs, tr = 6ns, tf = 6ns, Zo = 50Ω  
Vi = 8V
- (2) Input-output conditions : RL = 25Ω, Vo = 10V
- (3) Electrostatic capacity CL includes floating capacitance at connections and input capacitance at probes

**TIMING DIAGRAM**

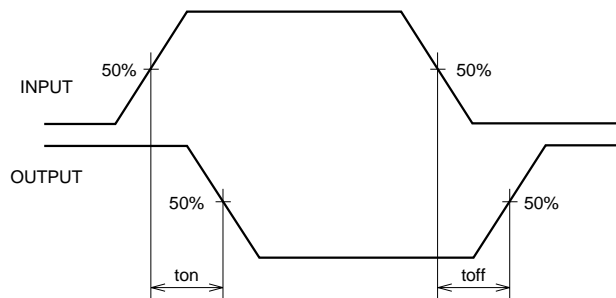

**M63828WP/DP**

Taiwan A'ssy product

7-UNIT 500mA DARLINGTON TRANSISTOR ARRAY WITH CLAMP DIODE

**TYPICAL CHARACTERISTICS**

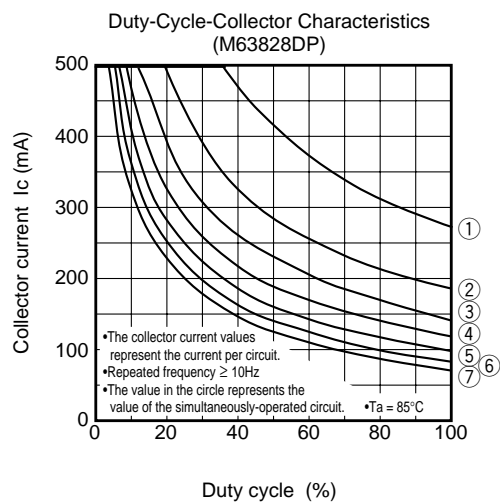
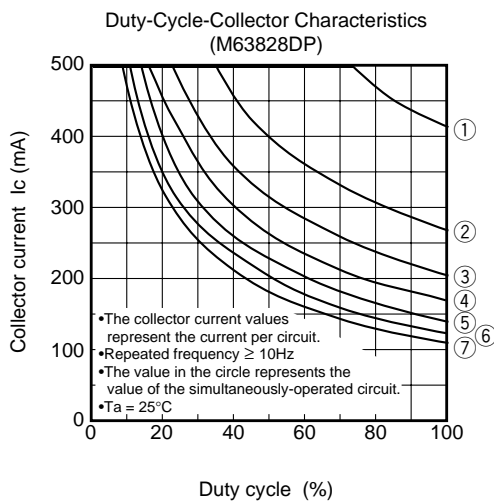
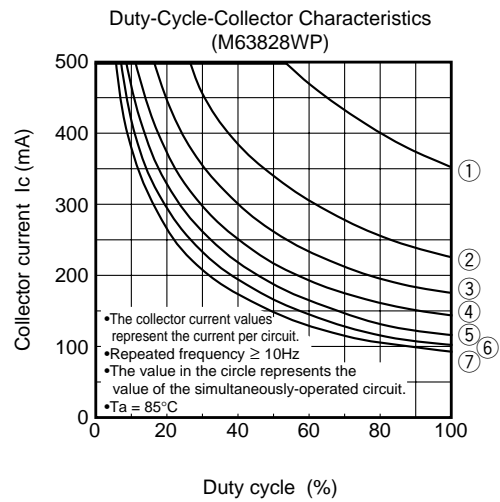
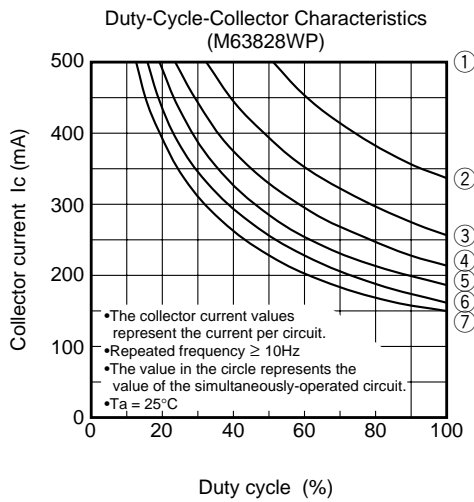
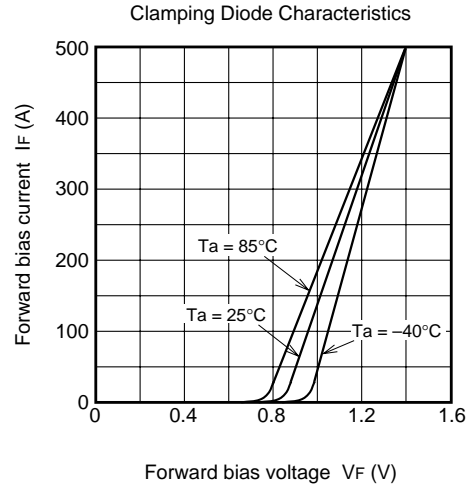
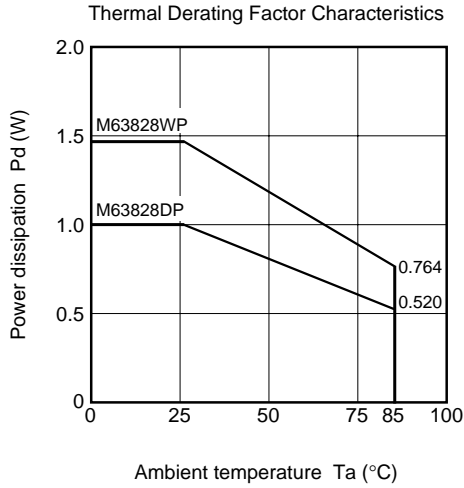

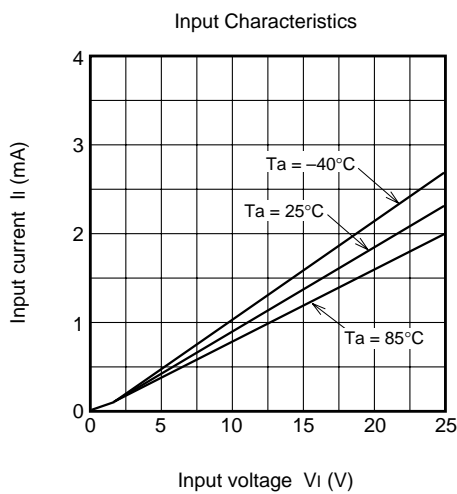
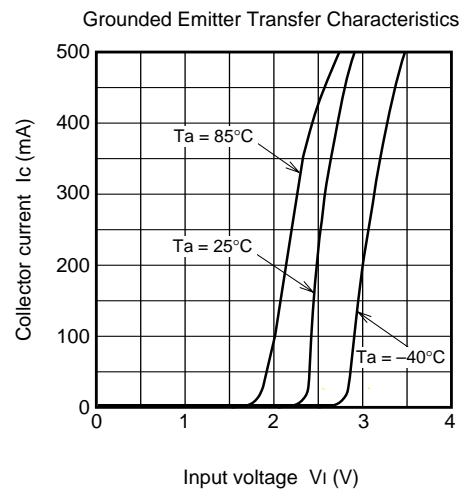
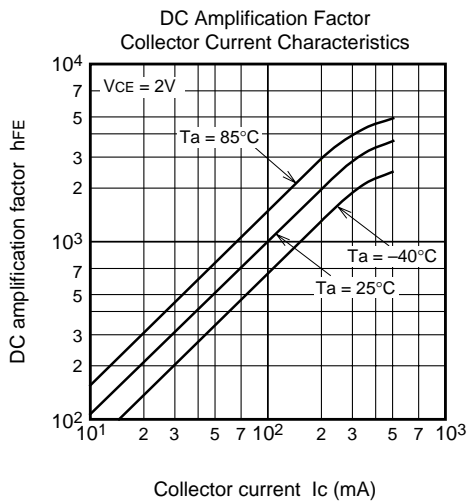
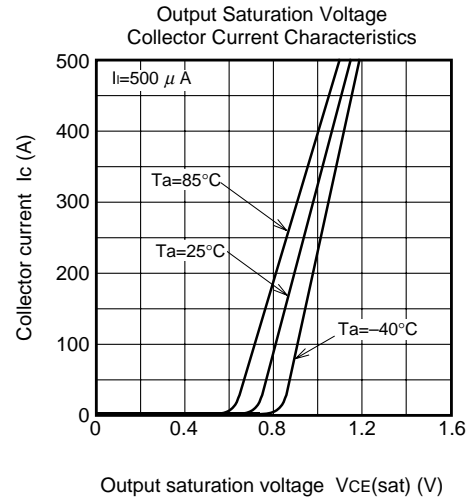
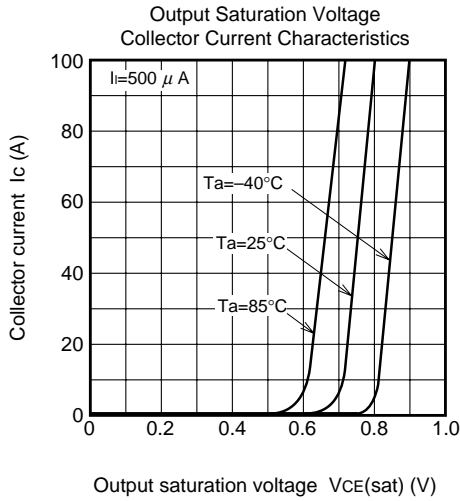

**M63828WP/DP**

Taiwan A'ssy product 7-UNIT 500mA DARLINGTON TRANSISTOR ARRAY WITH CLAMP DIODE

**PACKAGE OUTLINE**

**16P4X-A**

PACKAGE TYPE :  
16P4X-A 16PIN PLASTIC MOLD DUAL INLINE PACKAGE

Dimension in mm

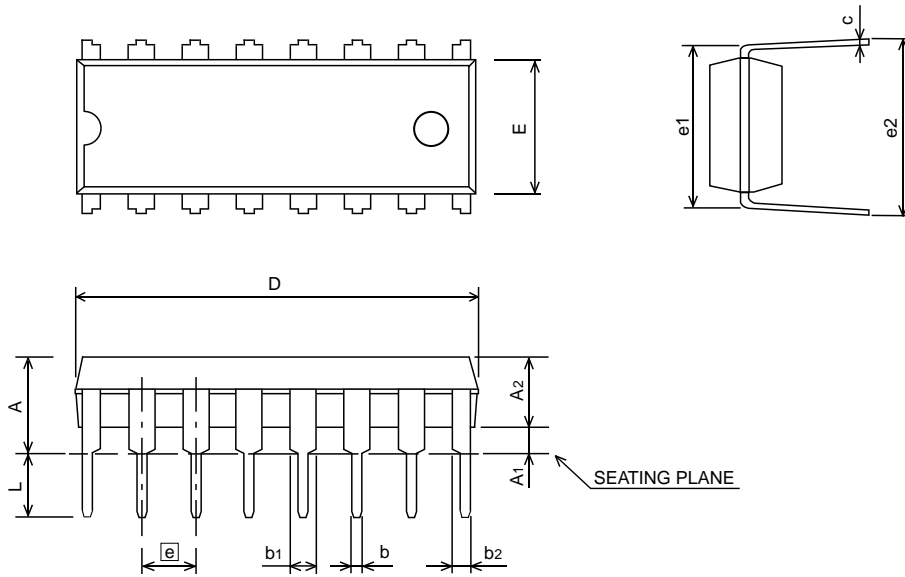

Symbol	Dimension in Millimeters		
	Min	Nom	Max
A	—	—	4.57
A1	0.38	—	—
A2	3.25	3.3	3.45
b	0.36	0.46	0.56
b1	1.14	1.52	1.78
b2	0.76	0.99	1.14
c	0.20	0.25	0.33
D	18.9	19.15	19.3
E	6.35	6.5	6.65
e	—	2.54	—
e1	7.62	7.94	8.26
e2	8.64	9.145	9.65
L	3.18	—	—

**M63828WP/DP**

Taiwan A'ssy product 7-UNIT 500mA DARLINGTON TRANSISTOR ARRAY WITH CLAMP DIODE

**16P2X-B**

PACKAGE TYPE :  
16P2X-B 16PIN PLASTIC MOLD SMALL OUTLINE PACKAGE

Dimension in mm

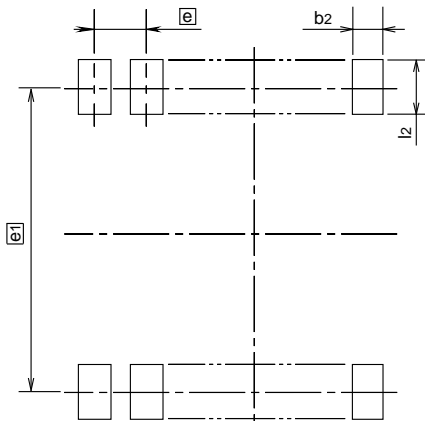
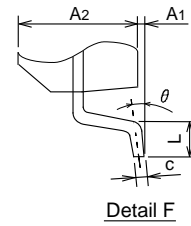
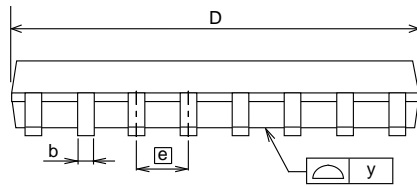
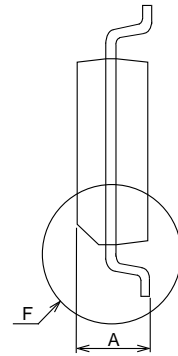
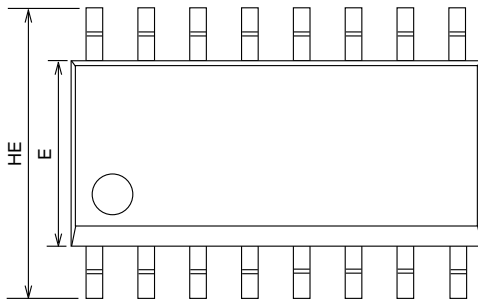

Recommended Mount Pad

Symbol	Dimension in Millimeters		
	Min	Nom	Max
A	1.47	1.6	1.73
A1	0.1	0.175	0.25
A2	—	1.45	—
b	0.402	0.41	0.42
c	0.19	0.2	0.25
D	9.8	9.91	10.01
E	3.81	3.91	3.99
e	—	1.27	—
HE	5.79	5.99	6.2
L	0.37	0.71	1.27
y	—	—	0.1
theta	0°	—	8°
b2	—	0.76	—
e1	—	5.72	—
l2	1.27	—	—