

PRELIMINARY
 Notice: This is not a final specification.
 Some parametric limits are subject to change.

M63830P/FP

4-UNIT 1.5A DARLINGTON TRANSISTOR-ARRAY WITH CLAMP DIODE

DESCRIPTION

The M63830P/FP 4-channel sinkdriver, consists of 4 PNP and 8 NPN transistors connected to form four high current gain driver pairs.

FEATURES

- High breakdown voltage ($BV_{CEO} \geq 50V$)
- High-current driving ($I_{C(max)} = 1.5A$)
- 3V micro computer series compatible input
- With clamping diodes
- With input diode
- Wide operating temperature range ($T_a = -40$ to $+85^\circ C$)

APPLICATION

Output for 3 voltage microcomputer series and interface with high voltage system. Relay and small printer driver, LED, or incandescent display digit driver.

FUNCTION

The M63830FP/P is transistor-array of high active level four units type which can do direct drive of 3 voltage microcomputer series. A resistor of $3.5k\Omega$ is connected between the input and the base of PNP transistors. A clamp diode for inductive load transient suppression is connected for the output pin (collector) and COM pin. The input diode is intended to prevent the flow of current from the input to the V_{CC} . Without this diode, the current flows from "H" input to the V_{CC} and the "L" input circuit is activated, in such a case where one of the inputs of the 4 circuit is "H" and the other are "L" to save power consumption. The diode is inserted to prevent such mis-operation. The outputs are capable of driving 1.5A and are rated for operation with output voltage up to 50V.

PIN CONFIGURATION

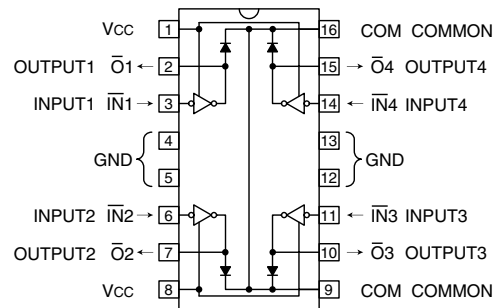

16P4(P)
 Package type 16P2N-A(FP)

CIRCUIT DIAGRAM

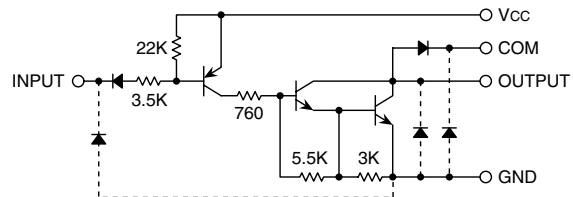

The four circuits share the COM and GND
 The diode, indicated with the dotted line, is parasitic, and cannot be used.

Unit : Ω

ABSOLUTE MAXIMUM RATINGS (Unless otherwise noted, $T_a = -40 \sim +85^\circ C$)

Symbol	Parameter	Conditions	Ratings	Unit
V_{CC}	Supply voltage		7	V
V_{CEO}	Collector-emitter voltage	Output, H	$-0.5 \sim +50$	V
I_C	Collector current	Current per circuit output, L	1.5	A
V_I	Input voltage		$-0.5 \sim V_{CC}$	V
V_R	Clamping diode reverse voltage		50	V
I_F	Clamping diode forward current	Pulse width $\leq 10ms$, duty cycle $\leq 5\%$	1.5	A
		Pulse width $\leq 100ms$, duty cycle $\leq 5\%$	1.0	
P_d	Power dissipation	$T_a = 25^\circ C$, when mounted on board	1.92(P)/1.00(FP)	W
T_{opr}	Operating temperature		$-40 \sim +85$	$^\circ C$
T_{stg}	Storage temperature		$-55 \sim +125$	$^\circ C$

PRELIMINARY
 Notice: This is not a final specification.
 Some parametric limits are subject to change.

4-UNIT 1.5A DARLINGTON TRANSISTOR-ARRAY WITH CLAMP DIODE

RECOMMENDED OPERATING CONDITIONS (Unless otherwise noted, Ta = -40 ~ +85°C)

Symbol	Parameter	Limits			Unit	
		min	typ	max		
Vcc	Supply voltage	2.7	3.0	3.6	V	
Vo	Output voltage	0	—	50	V	
Ic	Collector current (Current per 1 circuit when 4 circuits are coming on simultaneously)	Vcc = 3V, Duty Cycle P : no more than 5% FP : no more than 2%	0	—	1.25	A
		Vcc = 3V, Duty Cycle P : no more than 15% FP : no more than 7%	0	—	0.7	
VIH	"H" input voltage	Vcc-0.5	—	Vcc	V	
VIL	"L" input voltage	0	—	Vcc-2.2	V	

ELECTRICAL CHARACTERISTICS (Unless otherwise noted, Ta = -40 ~ +85°C)

Symbol	Parameter	Test conditions	Limits			Unit
			min	typ*	max	
V (BR) CEO	Collector-emitter breakdown voltage	ICEO = 100μA	50	—	—	V
ICC	Supply current (AN only Input)	VCC = 3.6V, VI = 0.5V	—	3.7	5.0	mA
VCE(sat)	Collector-emitter saturation voltage	VCC = 2.7V, VI = 0.5V, IC = 1.25A	—	1.4	2.2	V
		VCC = 2.7V, VI = 0.5V, IC = 0.7A	—	1.0	1.7	
II	Input current	VI = VCC-2.2V	—	-0.22	-0.6	mA
		VI = VCC-3.6V	—	-0.60	-0.95	
IR	Clamping diode reverse current	VR = 50V	—	—	100	μA
VF	Clamping diode forward voltage	IF = 1.25A, VCC open	—	1.5	2.3	V
hFE	DC amplification factor	VCC = 2.7V, VCE = 2V, IC = 1A, Ta = 25°C	4000	30000	—	—

* : Typical values are at Ta = 25°C

SWITCHING CHARACTERISTICS (Unless otherwise noted, Ta = 25°C)

Symbol	Parameter	Test conditions	Limits			Unit
			min	typ	max	
ton	Turn-on time	CL = 15pF (note 1)	—	190	—	ns
toff	Turn-off time		—	5300	—	ns

NOTE 1 TEST CIRCUIT

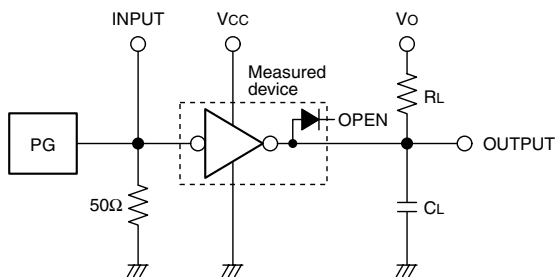

- (1) Pulse generator (PG) characteristics : PRR=1kHz, tw = 10μs, tr = 6ns, tf = 6ns, Zo = 50Ω, VI = 0.5 ~ 2.7V
- (2) Input-output conditions : RL = 8.3Ω, Vo = 10V, Vcc = 2.7V
- (3) Electrostatic capacity CL includes floating capacitance at connections and input capacitance at probes

TIMING DIAGRAM

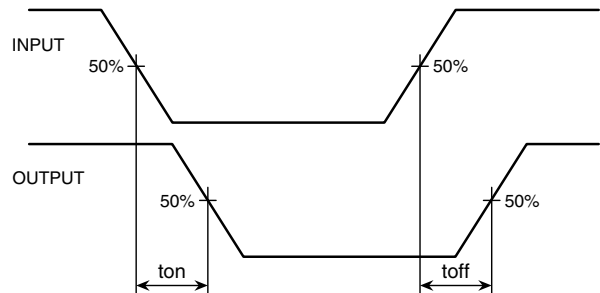

PRELIMINARY
 Notice: This is not a final specification.
 Some parametric limits are subject to change.

4-UNIT 1.5A DARLINGTON TRANSISTOR-ARRAY WITH CLAMP DIODE

TYPICAL CHARACTERISTICS

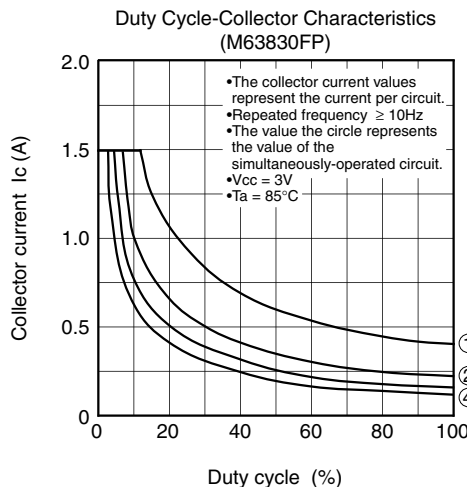
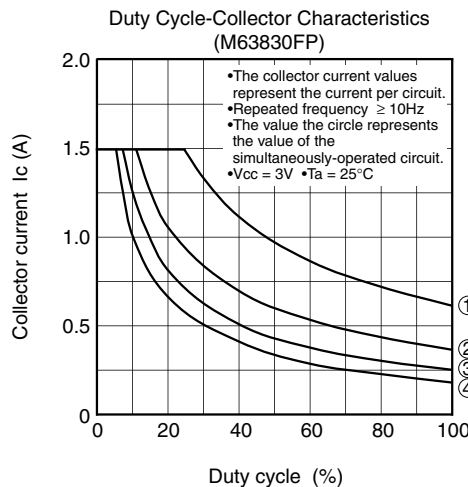
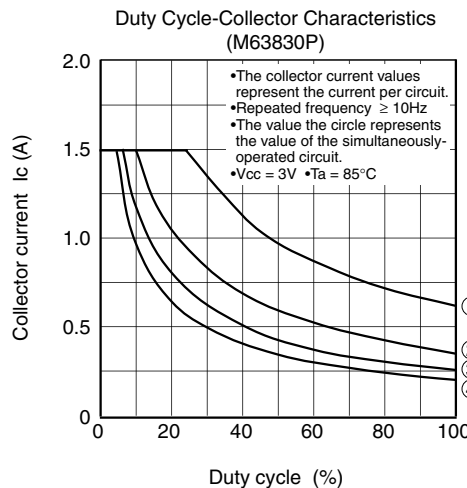
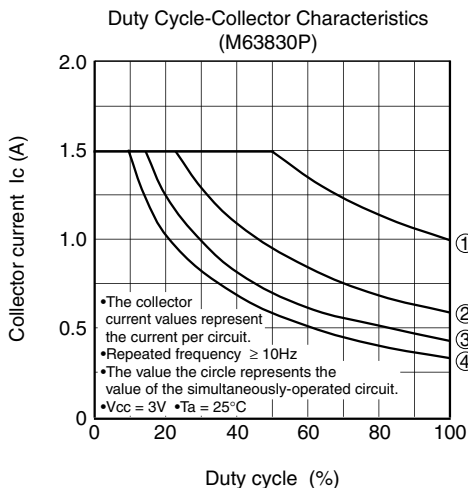
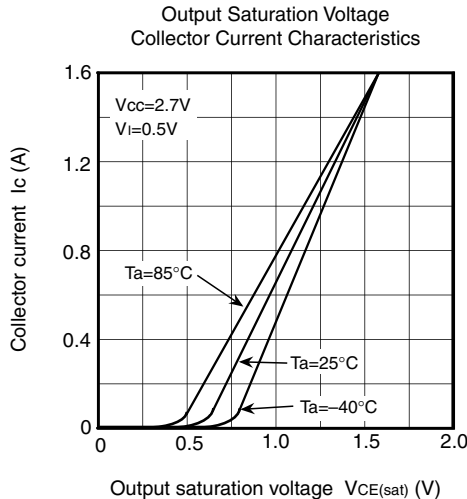
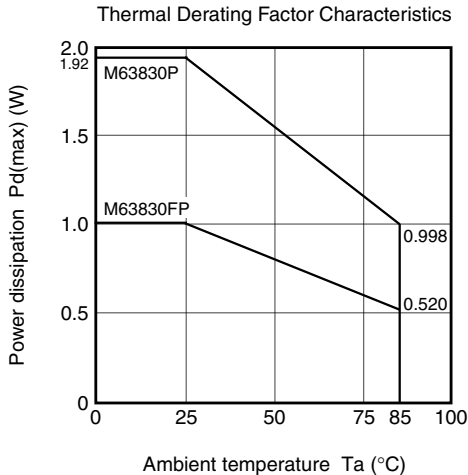

PRELIMINARY
 Notice: This is not a final specification.
 Some parametric limits are subject to change.

4-UNIT 1.5A DARLINGTON TRANSISTOR-ARRAY WITH CLAMP DIODE

DC Amplification Factor
 Collector Current Characteristics

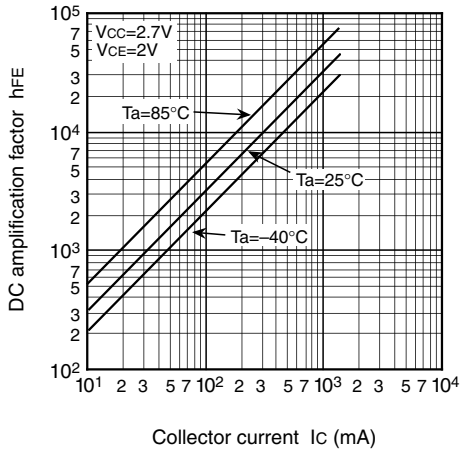

Grounded Emitter Transfer Characteristics

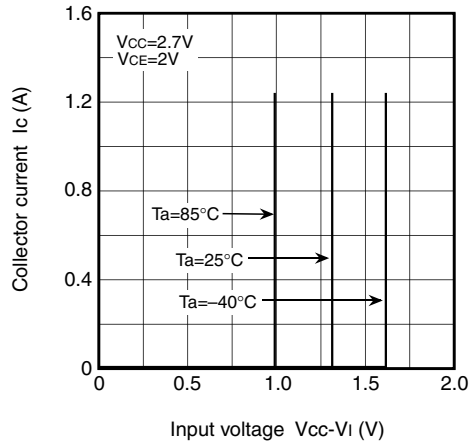

Input Characteristics

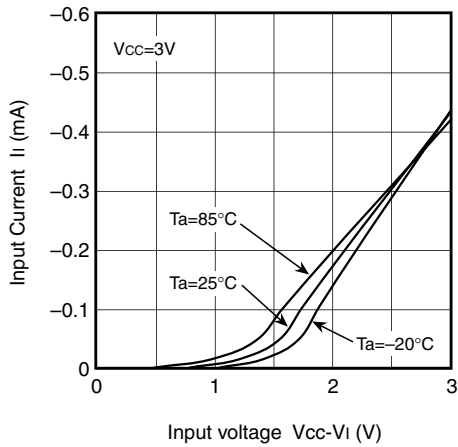

Clamping Diode Characteristics

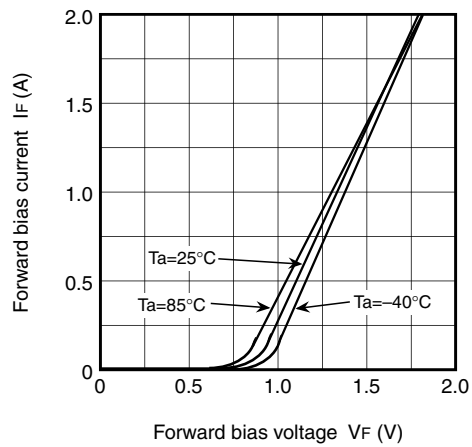

Driver Supply Characteristics

