

M63993FP

HIGH VOLTAGE 3PHASE BRIDGE DRIVER

DESCRIPTION

M63993FP is high voltage Power MOSFET and IGBT module driver for 3Phase bridge applications.

FEATURES

- FLOATING SUPPLY VOLTAGE 600V
- OUTPUT CURRENT ±300mA
- 3PHASE BRIDGE DRIVER
- SSOP-36

APPLICATIONS

MOSFET and IGBT inverter module driver for refrigerator, air-conditioner, washing machine, AC-servomotor and general purpose.

PIN CONFIGURATION (TOP VIEW)

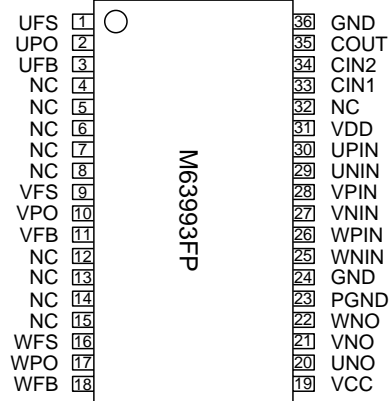

NC:NO CONNECTION

PACKAGE TYPE 36P2R

BLOCK DIAGRAM

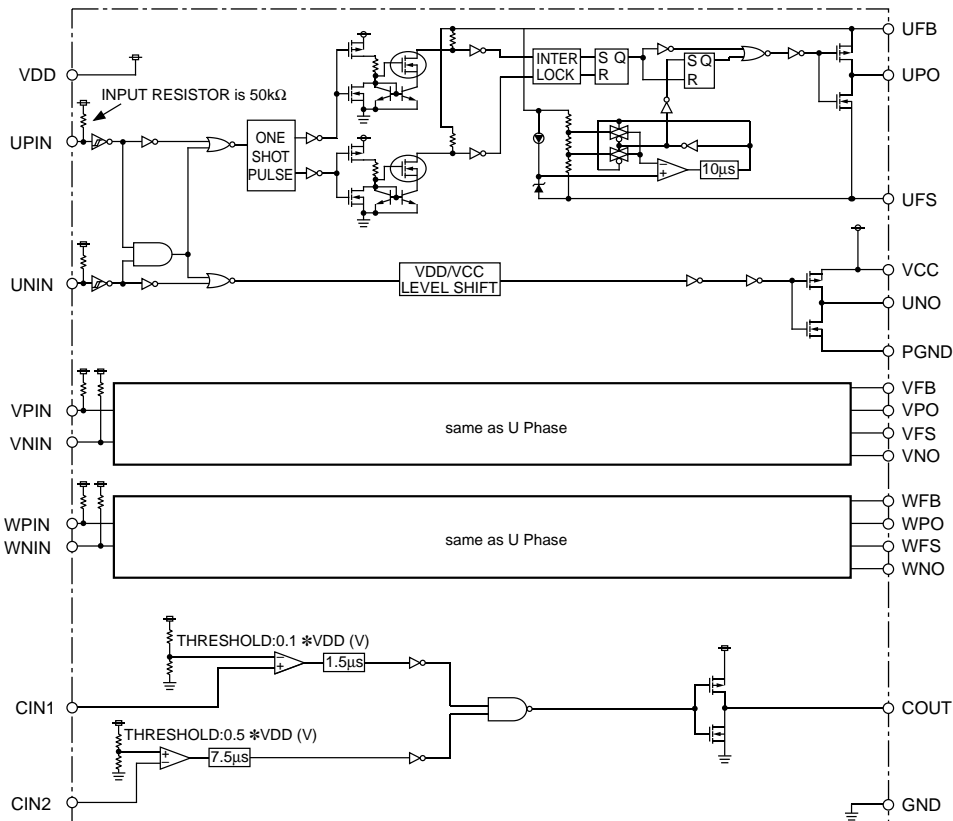

ABSOLUTE MAXIMUM RATINGS

Symbol	Parameter	Conditions	Ratings	Unit
U, V, WFB	High Side Floating Supply Voltage		-0.5~624	V
U, V, WFS	High Side Floating Supply Offset Voltage		VB-24 ~ VB+0.5	V
VU, V, WPO	High Side Output Voltage		VS-0.5 ~ VB+0.5	V
VCC	Low Side Fixed Supply Voltage		-0.5 ~ 24	V
VU, V, WNO	Low Side Output Voltage		-0.5 ~ VCC+0.5	V
VDD	Logic Supply Voltage		-0.5 ~ 7	V
VIN	Logic Input Voltage	U, V, WPI N, U, V, WNI N	-0.5 ~ VDD+0.5	V
dVS/dt	Allowable Offset Supply Voltage Transient		±50	V/ns
Pt	Package Power Dissipation	Ta = 25°C, On Board	1.2	W
K θ	Linear Derating Factor	Ta > 25°C, On Board	12.0	mW/°C
Rth(j-c)	Junction Case Thermal Resistance		30	°C/W
Tj	Junction Temperature		-30 ~ 125	°C
Topr	Operation Temperature		-30 ~ 100	°C
Tstg	Storage Temperature		-40 ~ 125	°C

RECOMMENDED OPERATING CONDITIONS

Symbol	Parameter	Test Conditions	Limits			Unit
			Min.	Typ.	Max.	
U, V, WFB	High Side Floating Supply Voltage		VS+10	—	VS+20	V
U, V, WFS	High Side Floating Supply Offset Voltage		-5	—	500	V
VCC	Low Side Fixed Supply Voltage		10	—	20	V
VDD	Logic Supply Voltage		4.5	—	5.5	V
VIN	Logic Input Voltage	U, V, WPI N, U, V, WNI N	0	—	VDD	V
VPDND	Output GND Voltage		-5	—	5	V

FUNCTION TABLE 1 (INPUT, OUTPUT and UV)

U, V, WPIN	U, V, WNIN	UV	U, V, WPO	U, V, WNO	Behavioral state
H	H	H	L	L	Normal OFF
H	L	H	L	H	*NO ON
L	H	H	H	L	*PO ON
L	L	X	L	L	*PO = OFF, *NO = OFF, *PIN = *NIN = L simultaneously
X	H	L	L	L	*PO OFF, *VB UV tripped
H	L	L	L	H	*NO ON, *VB UV tripped

Note : "L" state of *VB UV mean that UV trip voltage.

FUNCTION TABLE 2 (COMPARATOR)

CIN1	CIN2	COUT	Behavioral state
L	H	H	COUT is normal HIGH
H	X	L	
X	L	L	

ELECTRICAL CHARACTERISTICS (Ta=25°C, VCC=VBS=15V, VDD=5V unless otherwise specified)

Symbol	Parameter	Test conditions	Limits			Unit
			Min.	Typ.	Max.	
IFS	Floating Supply Leakage Current	VB=VS=600V per 1 phase	—	—	1	μA
IBS	VBS standby Current		—	0.48	—	mA
ICC	VCC standby Current		—	—	0.1	mA
IDD	VDD standby Current		—	0.5	—	mA
VOH	High Level Output Voltage	IO=0A, *NO, *PO	14.9	—	—	V
VOL	Low Level Output Voltage	IO=0A, *NO, *PO	—	—	0.1	V
VIH	High Level Input Threshold Voltage	*PIN, *NIN	2.1	3.0	4.0	V
VIL	Low Level Input Threshold Voltage	*PIN, *NIN	0.6	1.5	1.9	V
IIH	High Level Input Bias Current	*PIN, *NIN=5V	—	—	1.0	μA
IIL	Low Level Input Bias Current	*PIN, *NIN=0V	—	100	300	μA
VUVT	VBS Supply UV Trip Voltage		7.0	8.0	9.0	V
VUVR	VBS Supply UV Reset Voltage		7.5	8.5	9.5	V
tUV	VBS Supply UV Filter Time		—	7.5	—	μs
IOH	Output High Level Short Circuit Pulsed Current	*PO*NO=0V, *PIN, *NIN=5V,PW<10μs	—	-300	—	mA
IOL	Output Low Level Short Circuit Pulsed Current	*PO*NO=15V, *PIN, *NIN=0V,PW<10μs	—	300	—	mA
tdLH(HO)	High Side Turn-On Propagation Delay	CL=1000pF between HO – VS	250	300	350	ns
tdHL(HO)	High Side Turn-Off Propagation Delay	CL=1000pF between HO – VS	230	280	330	ns
tr(HO)	High Side Turn-On Rise Time	CL=1000pF between HO – VS	—	130	—	ns
tf(HO)	High Side Turn-Off Fall Time	CL=1000pF between HO – VS	—	100	—	ns
tdLH(LO)	Low Side Turn-On Propagation Delay	CL=1000pF between LO – GND	250	300	350	ns
tdHL(LO)	Low Side Turn-Off Propagation Delay	CL=1000pF between LO – GND	230	280	330	ns
tr(LO)	Low Side Turn-On Rise Time	CL=1000pF between LO – GND	—	130	—	ns
tf(LO)	Low Side Turn-Off Fall Time	CL=1000pF between LO – GND	—	100	—	ns
VCIN1th	Comparator 1 Threshold Voltage	VDD=5V	0.47	0.5	0.53	V
tVCIN1	Comparator 1 Filter Time		—	1.5	—	μs
VCIN2th	Comparator 2 Threshold Voltage	VDD=5V	2.4	2.5	2.6	V
tVCIN2	Comparator 2 Filter Time		—	7.5	—	μs
VCOH	Comparator H Level Output Voltage	ICO=500μA	4.5	—	—	V
VCOL	Comparator L Level Output Voltage	ICO=-500μA	—	—	0.5	V

LEAD DEFINITIONS

Lead symbol	Description
UFS, VFS, WFS	High Side floating supply (minus side)
UPO, VPO, WPO	High side gate drive output
UFB, VFB, WFB	High Side floating supply (plus side)
VCC	Low side supply
UNO, VNO, WNO	Low side gate drive output
PGND	Low side power ground
UNIN, VNIN, WNIN	Logic input for low side gate driver output (LO)
UPIN, VPIN, WPIN	Logic input for high side gate driver output (HO)
VDD	Logic supply
CIN1	Input for comparator 1
CIN2	Input for comparator 2
COUT	Comparator output

TIMING DIAGRAM

1. Input/Output Timing Diagram

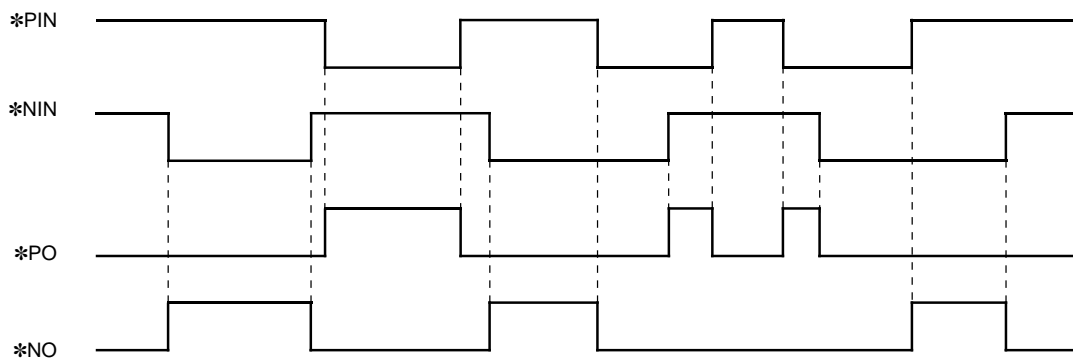

2. VBS Supply Undervoltage Lockout Timing Diagram

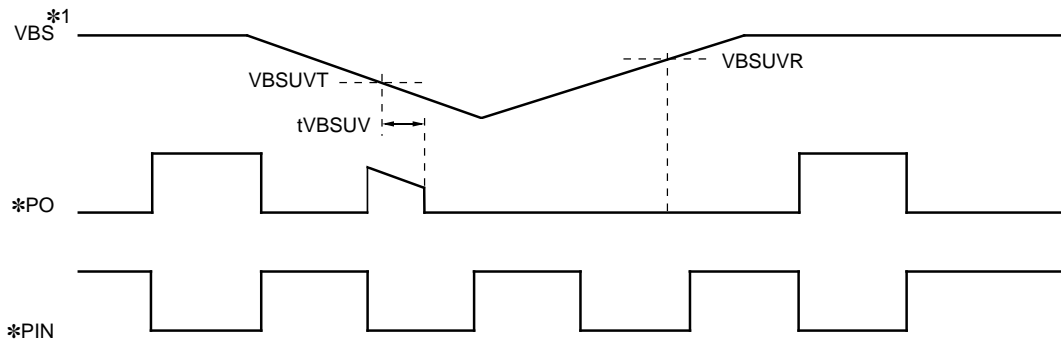

*1: $VBS = *FB \cdot *FS$

PERFORMANCE CURVES

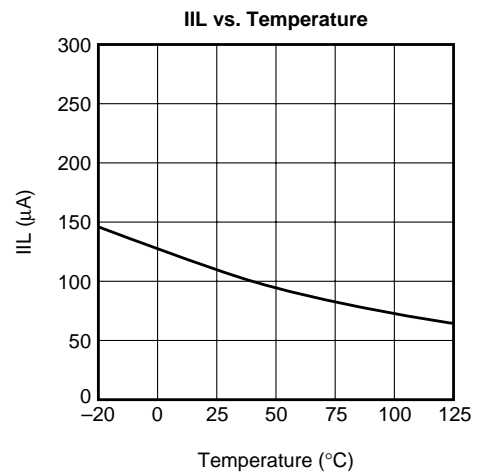
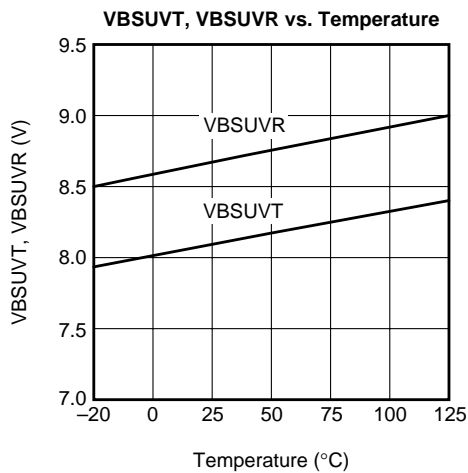
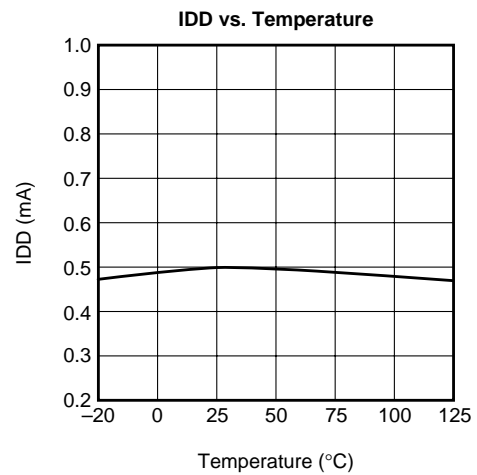
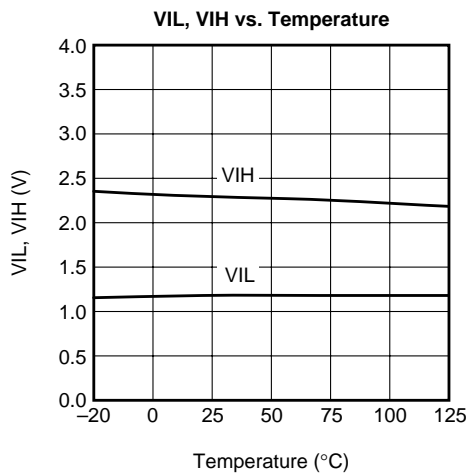
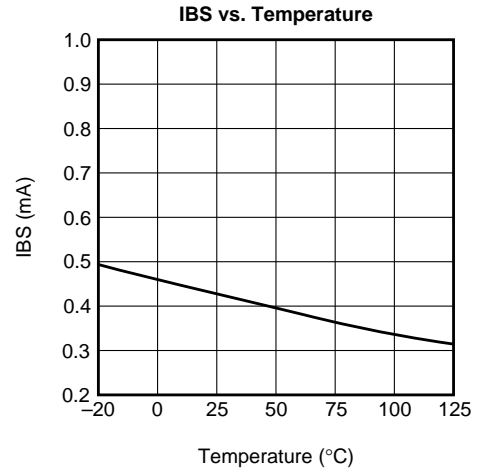
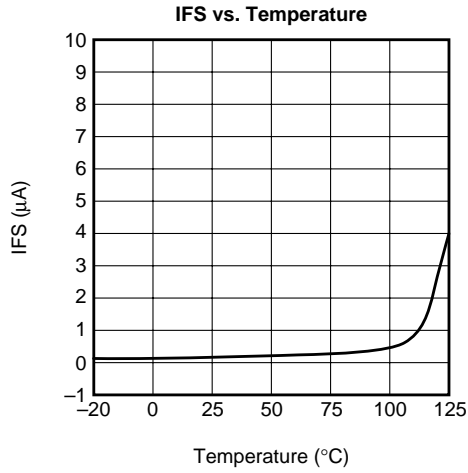

HIGH VOLTAGE 3PHASE BRIDGE DRIVER

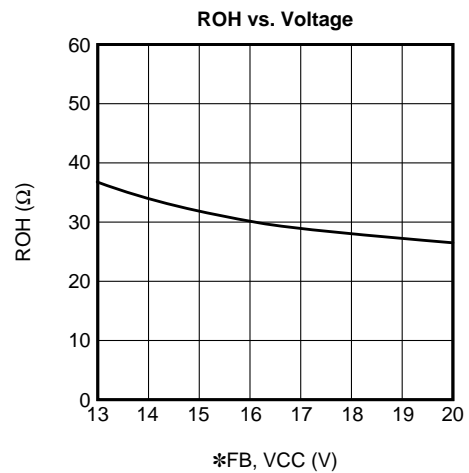
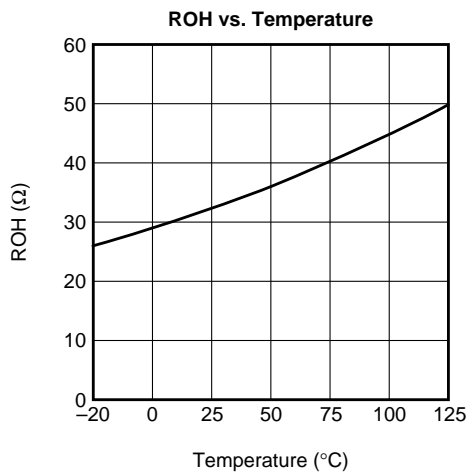
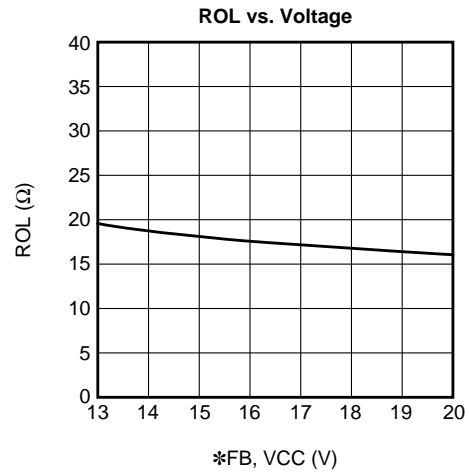
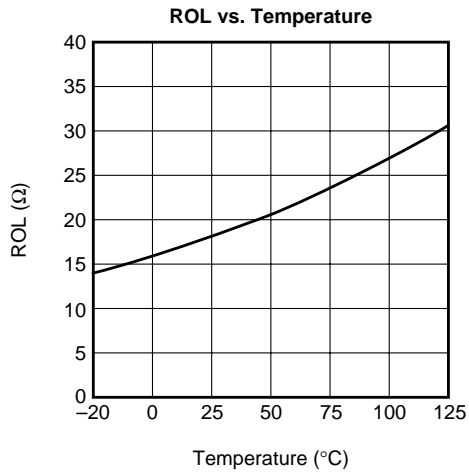
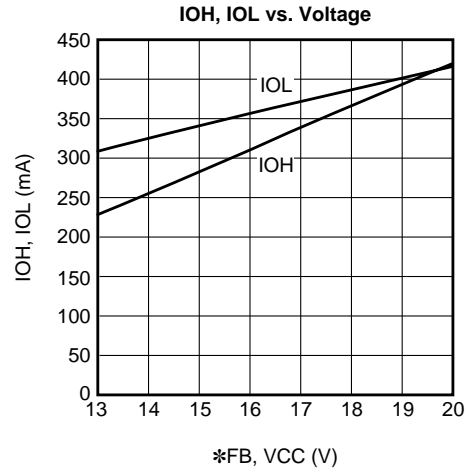
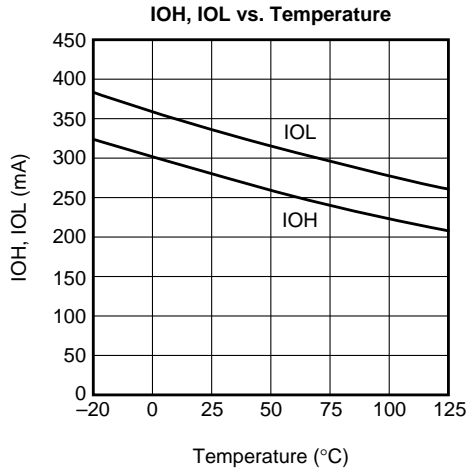

M63993FP

HIGH VOLTAGE 3PHASE BRIDGE DRIVER

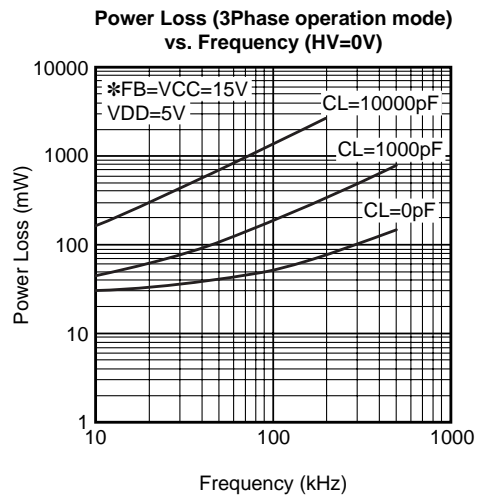
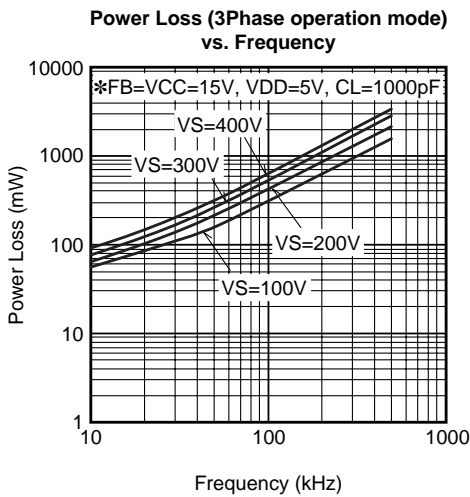
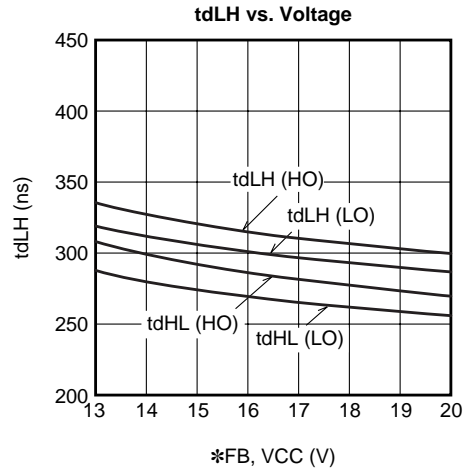
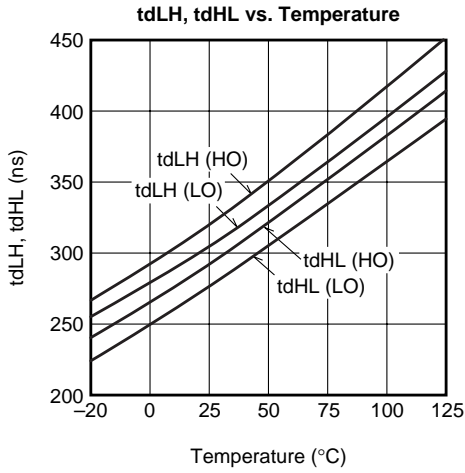

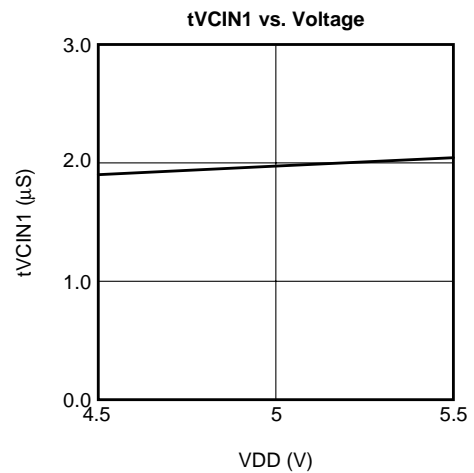
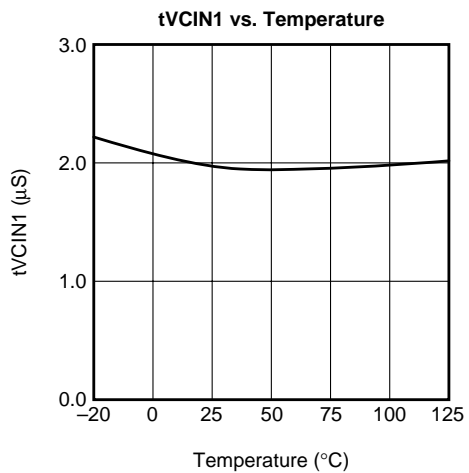
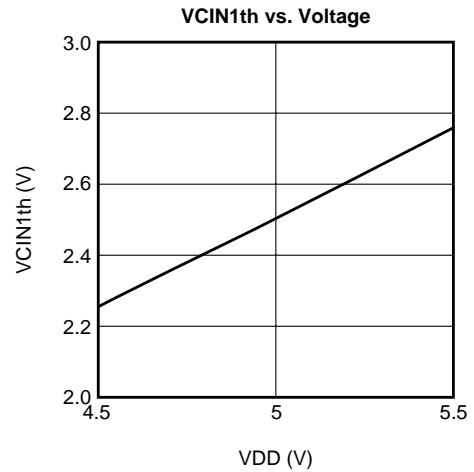
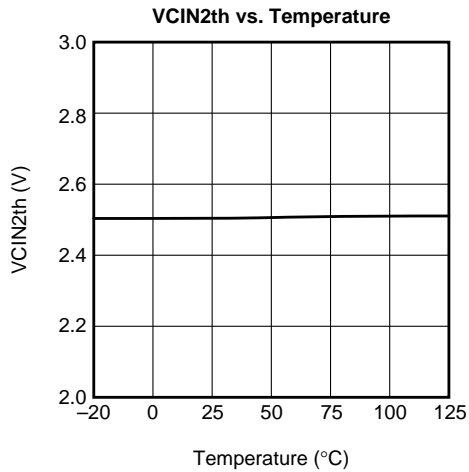
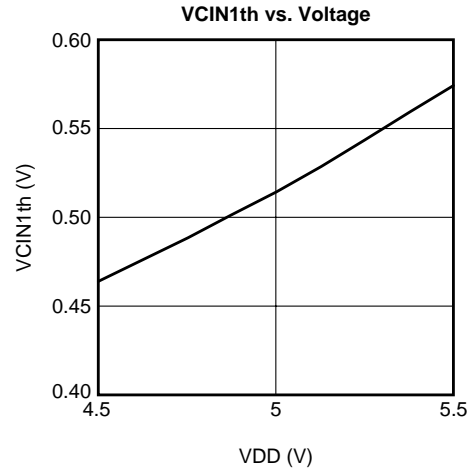
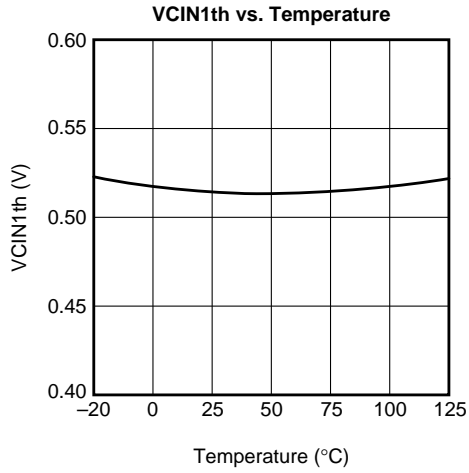

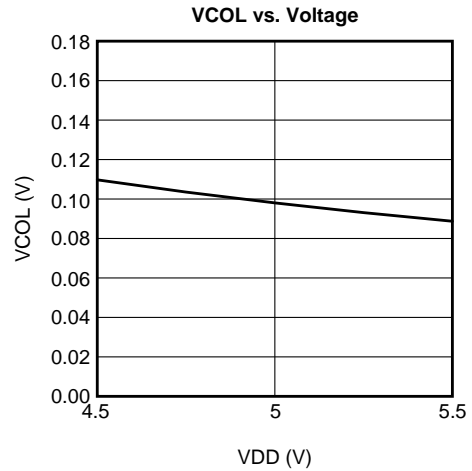
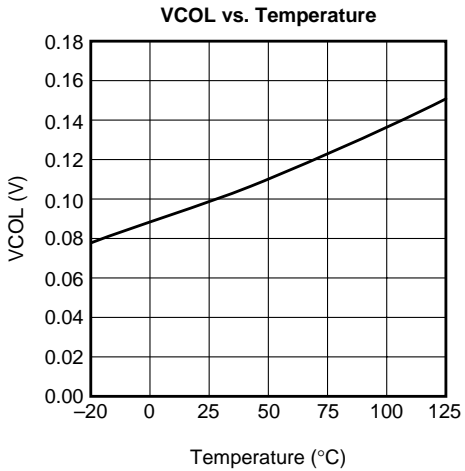
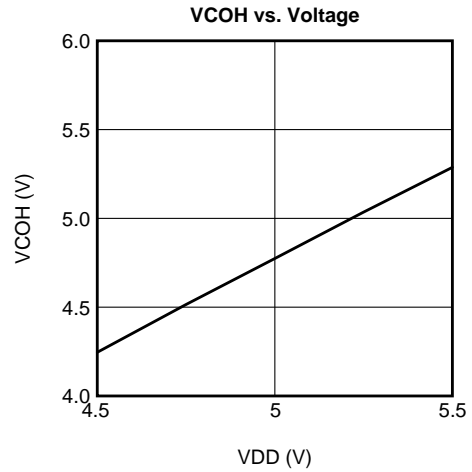
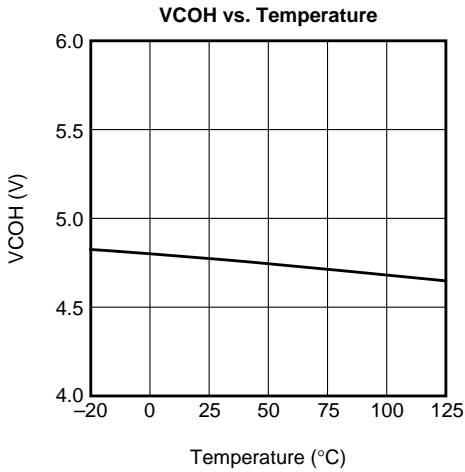
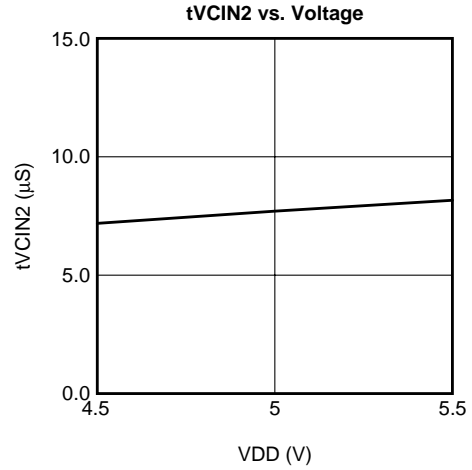
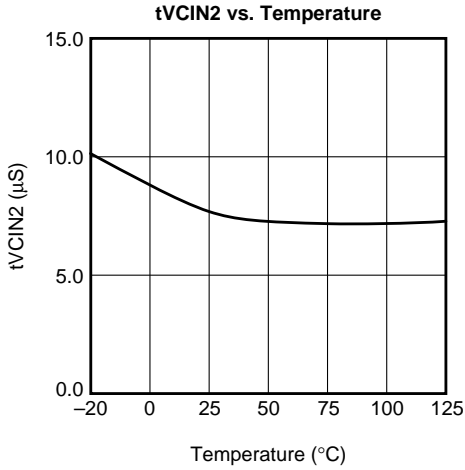

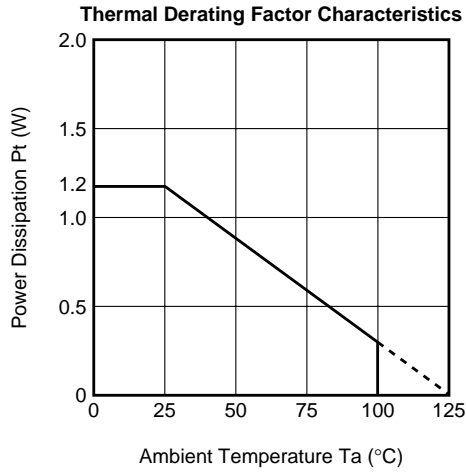

PACKAGE OUTLINE

36P2R-D

Plastic 36pin 450mil SSOP

EIAJ Package Code	JEDEC Code	Weight(g)	Lead Material
SSOP36-P-450-0.80	-	0.53	Cu Alloy

Recommended Mount Pad

Symbol	Dimension in Millimeters		
	Min	Nom	Max
A	-	-	2.35
A1	0	0.1	0.2
A2	-	2.05	-
b	0.3	0.35	0.45
c	0.18	0.2	0.25
D	14.8	15.0	15.2
E	8.2	8.4	8.6
e	-	0.8	-
HE	11.63	11.93	12.23
L	0.3	0.5	0.7
L1	-	1.765	-
y	-	-	0.1
θ	0°	-	8°
b2	-	0.5	-
e1	-	11.43	-
l2	1.27	-	-